

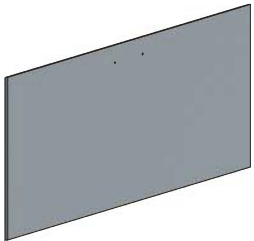

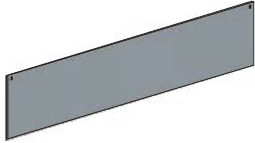









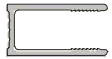

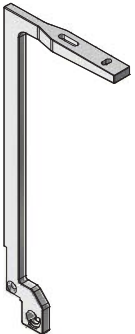







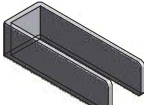

## GDO1N

POS.	PREVIEW	PCS	SPARE PART
1		1	V221
2		1	V220
3		1	ND01-4036
4		1	ND01-4036
5		1	ND01-4036
6		1	ND01-4036
7		1	ND01-4037
8		1	ND01-4036
9		1	MA7203
10		1	ND01-4040
11		1	MA7196
12		1+1	ND01-4039
13		1	ND01-4037
14		1	ND01-4038

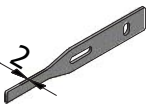
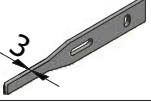
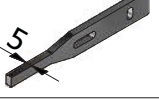
## GDO1N

POS.	PREVIEW	PCS	SPARE PART
15		2	ND01-2420
16	-	-	-
17		1	ND01-4040
18		1	ND01-4035
19		2	ND01-4035
20		1	ND01-4035
21		5	ND01-4035
22		5	ND01-4035
23		2	ND01-4035
24		1	ND01-4040
25		1	ND01-4040
26		1	ND01-4035
27		1	ND01-4035
28		1	ND01-4035
29			ND01-4035
30			ND01-4035
31			ND01-4035

V221

V220

ND01-4035

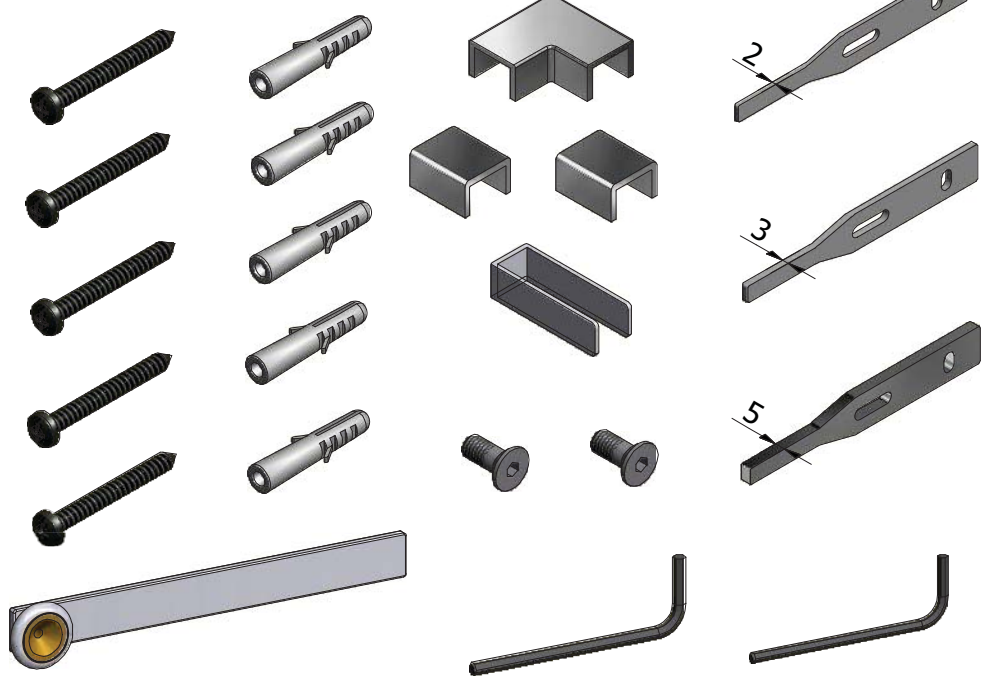
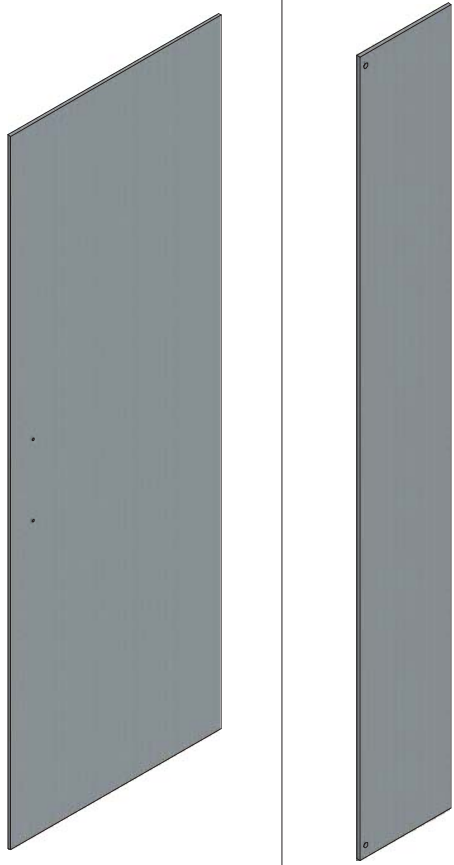

ND01-4036

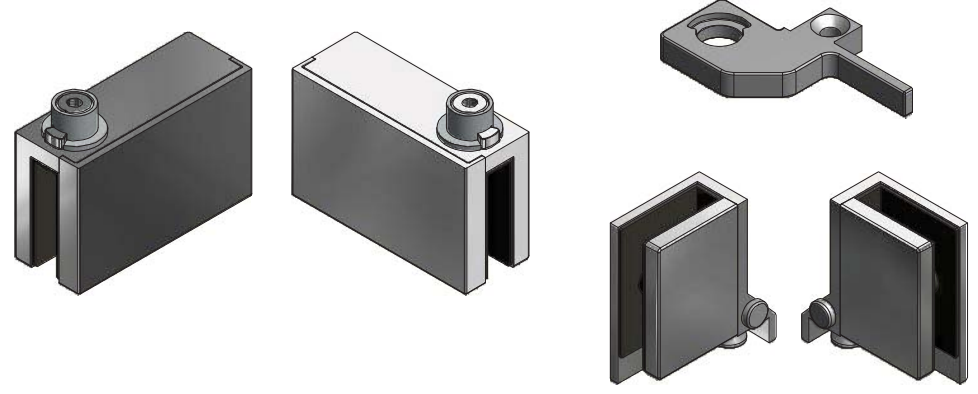

ND01-4037

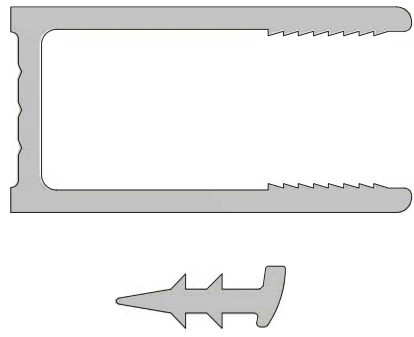

ND01-4039



MA7203

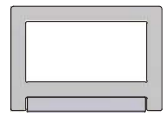

ND01-4040

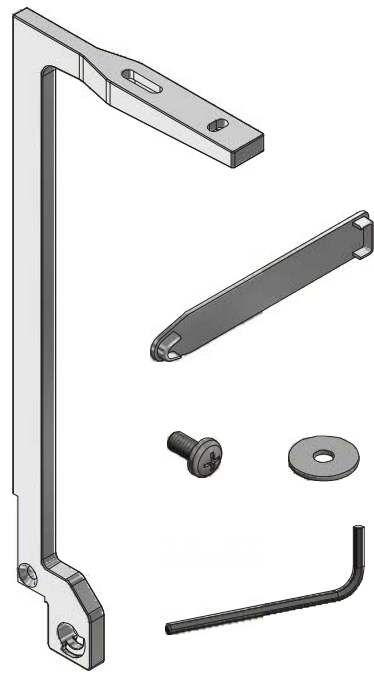

ND01-4038

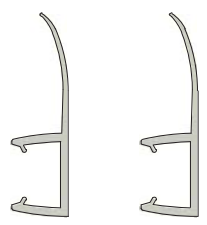

MA7196



ND01-2420

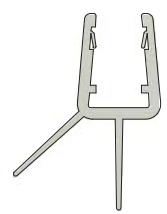

V220	800;900;1000;1100;1200	Transparent	ND01-3621
------	------------------------	-------------	-----------

V221	800	Transparent	ND01-3622
	900		ND01-3623
	1000		ND01-3624
	1100		ND01-3625
	1200		ND01-3626